

DRAWING

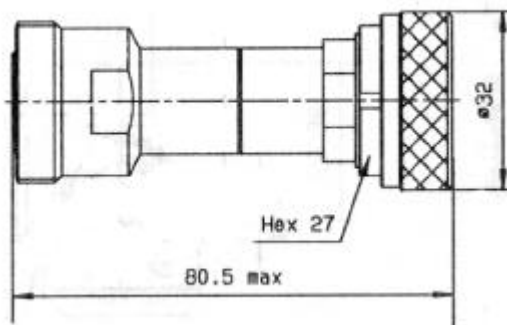

General tolerances : ± 0.5 mm

R. F. CHARACTERISTICS

FREQUENCY RANGE : DC – 4 GHz
 IMPEDANCE : 50 Ω
 ATTENUATION NOMINAL : 6 dB

FREQUENCY	DC – 2 GHz	2 – 4 GHz
V.S.W.R.	<= 1.20	<= 1.30
DEVIATION (dB)	+ 0.3 / - 0.3	+ 0.5 / - 0.5

TEMPERATURE SENSITIVITY : 4 * (10⁻⁴ dB / dB * °C)
 AVERAGE POWER HANDLING at 25° : 1 W
 PEAK POWER HANDLING(1µs , 1%o) at 25° C : 100 W

MECHANICAL CHARACTERISTICS

CONNECTORS : 7/16 male / female per IEC 169-4
 WEIGHT : ≤ 205 g

ENVIRONNEMENTAL CHARACTERISTICS

OPERATING TEMPERATURE RANGE (°C) : - 40 ; + 85
 STORAGE TEMPERATURE RANGE (°C) : - 40 ; + 85

Power derating
Versus temperature

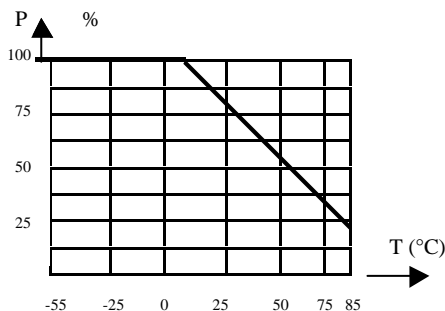

CREATION					RADIALL
N°:					101, rue P. Hoffmann
PEN/EP : H920016					93116 ROSNY/BOIS
Name:M.G.					France
Date:24 Apr.96	2 jun 99	New connector body	MG	AF	Tel : (33) 0149353535
Appr.: AF.	Issue	Revisions	Name	Appr.	Fax : (33) 0148546363